



C&P s.r.l.

Prefabbricati e Precompressi

Francavilla In Sinni (PZ)

Tel. 0973/642261 - Fax 0973/642263

www.cepsrl.net

Settore : PREFABBRICAZIONE

Tavola :

Componente : TRAVE A CASSONE 100/200h

Articolo :

Codice :

edizione :

SEZIONE TRAVE IN TESTATA

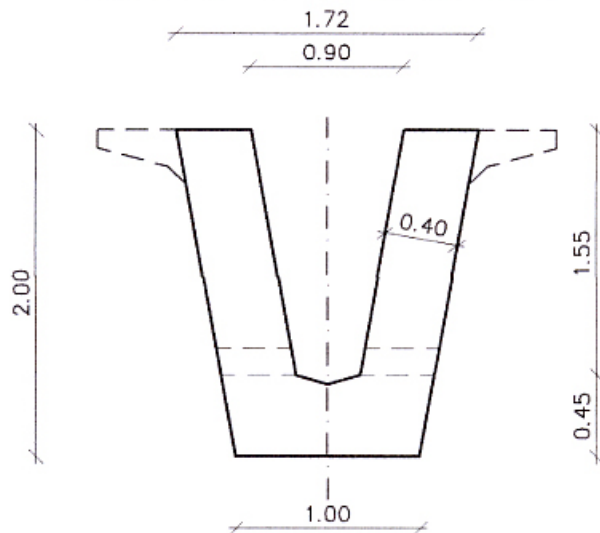

SEZIONE DI RACCORDO

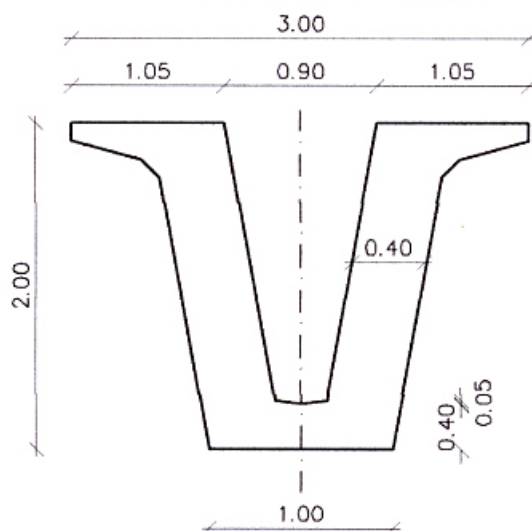

SEZIONE CORRENTE

